

20X40MM. TYPE 1

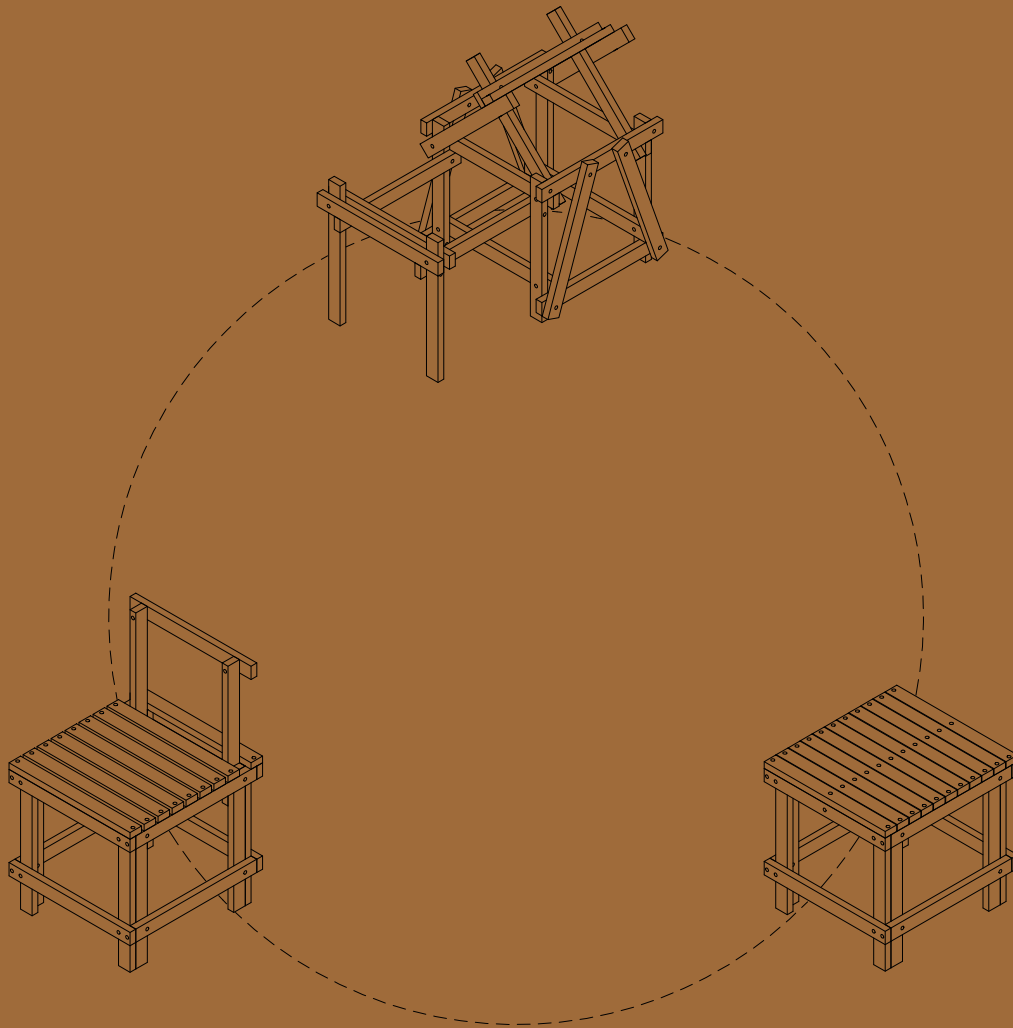

BIY SYSTEM

This system is developed for people who are not specially attracted to DIY activities. The goal is to provide extremely easy, fast, cheap and robust guidelines to build your own structures in a smooth, easeful and enjoyable way. Some of them provide an intimate satisfaction of being able to make something by yourself, others are designed to be built among two people, so by building together we create new or strengthen old bonds.



Table Hut model. 2019.

MATERIAL

Each 20x40 mm. type is made from full optimization of standard 20x40x3000mm. pine battens. There is no wasted material besides the sawdust from cutting the battens into smaller parts. You can alternatively use other types of trees than pine.

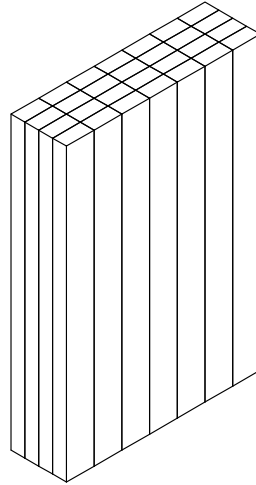

A bunch of pine strips.

QUESTION: WHICH LENGTHS AND QUANTITY OF 20X40 MM BATTENS CAN ALLOW FOR THE MAXIMUM NUMBER OF DIFFERENT FURNITURE VARIATIONS?

Some periods in our life we might need a small hut for our kids, that later can be easily turned into some robust chair, a table for them to draw on, or stool to sit while having dinner in the terrace. With standard pine battens as a point of departure, we find the parts sizes and number that will allow for the maximum number of different furniture. Here we include a stool, a chair and a hut as examples, but there are many more configurations you can develop on your own.

HYPOTHESIS AND PREDICTION

Once a basic frame is defined, it is easier and faster to slightly transform it into different structures. We will pick the frame that allows us more configurations possibility.

EXPERIMENT AND PROTOTYPES

We tested the real size of the parts after cutting them, the rigidity of the joints and stability of the different configurations to refine the position of the bracing elements so they were also comfortable to lean small feet on them.



Stool prototype fabrication.



Chair prototype fabrication.



Chair prototype fabrication.



Chair prototype fabrication.

HUT

It is the smallest hut for a new born. But it is also the smallest porch in the world. So that since day one we learn to enjoy the benefit of these shaded and cool, or sunny and warm structures.

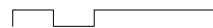
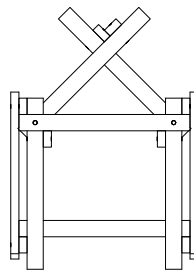
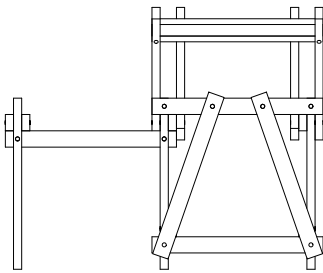
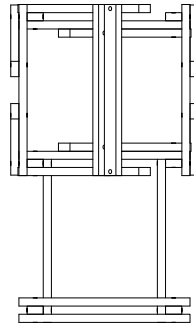
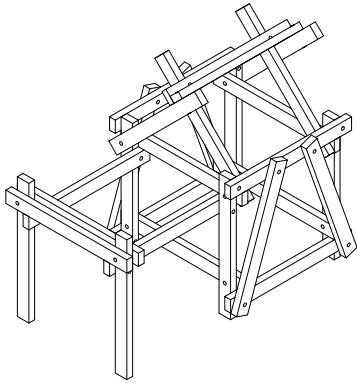

Anatomy.

material: 4 pine battens 3.000x20x40 mm
 tools: drill bit 30mm
 screws: universal screws 3,5x30mm; flathead z2

(x) = (cut width)
 x = distance between predrilling centers,
 or between part end and predrilling center

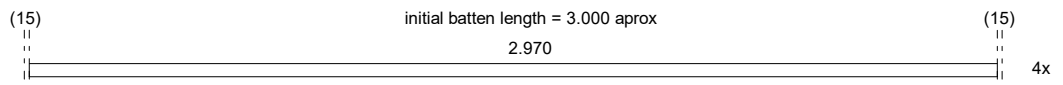

cut:

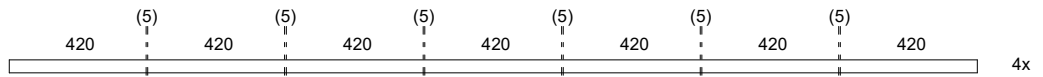

predrill:

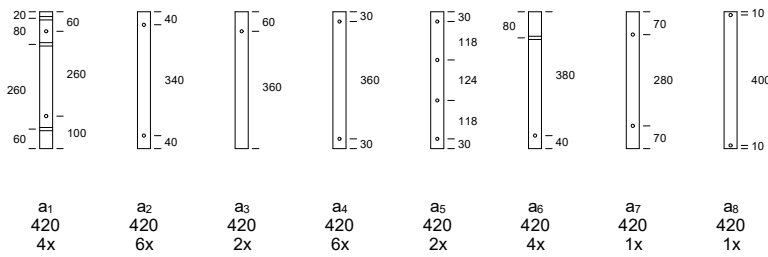

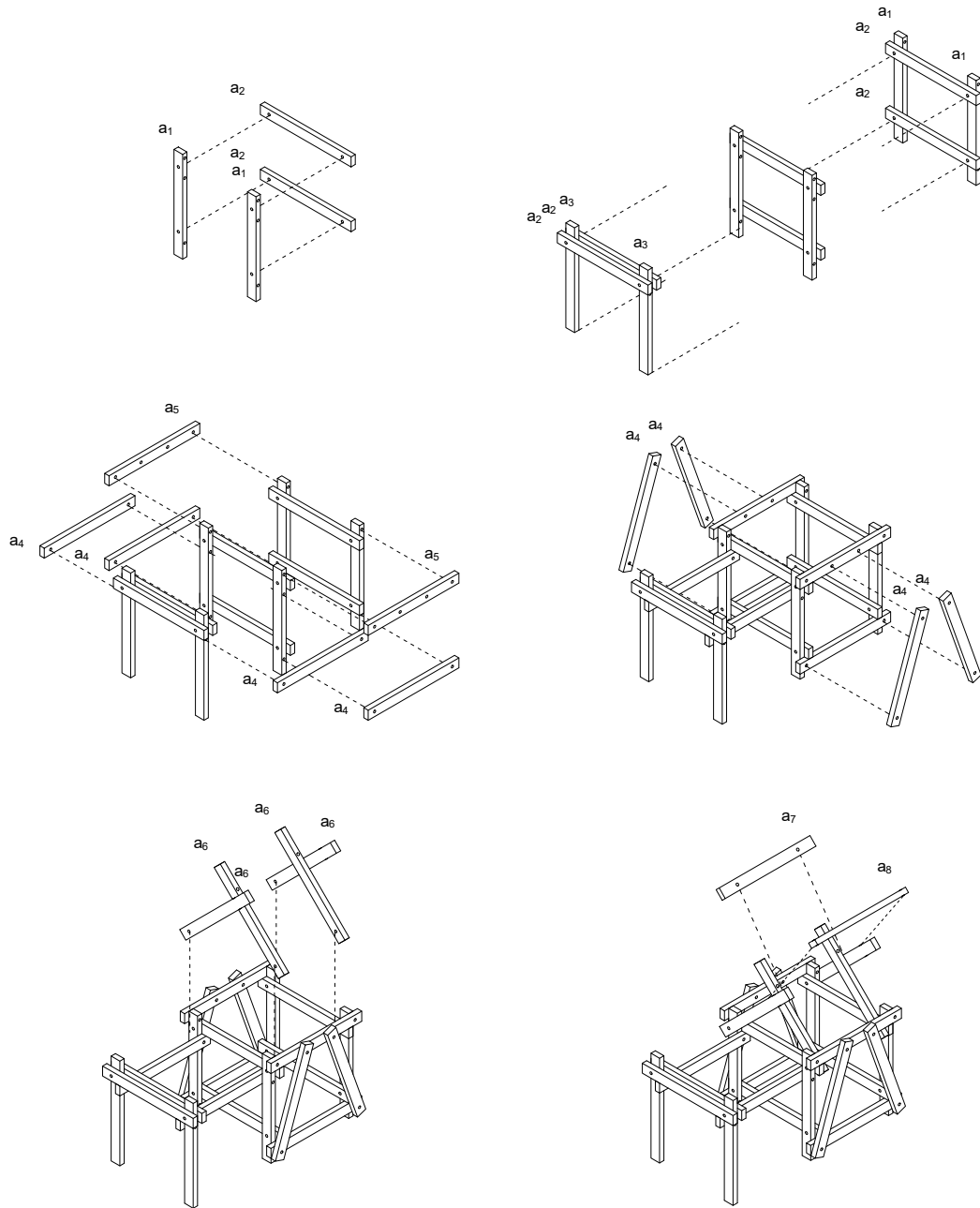

Assembly steps.

CHAIR

A robust seat that suggests a dynamic position of your hips, back, shoulders and neck.

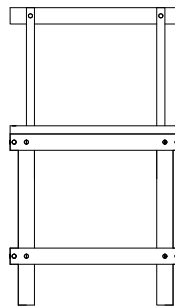
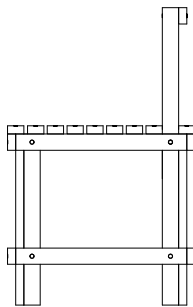
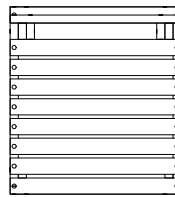
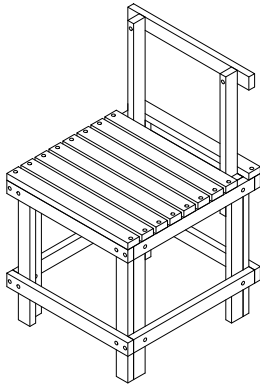

Anatomy.

material: 4 pine battens 3.000x20x40 mm
 tools: drill bit 30mm
 screws: universal screws 3,5x30mm; flathead z2

(x) = (cut width)
 x = distance between predrilling centers,
 or between part end and predrilling center

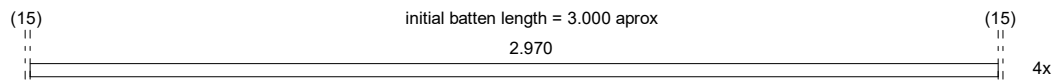

cut:

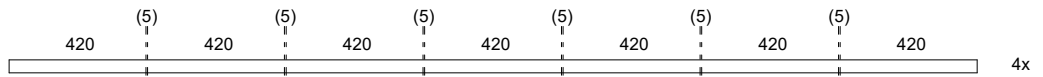

predrill:

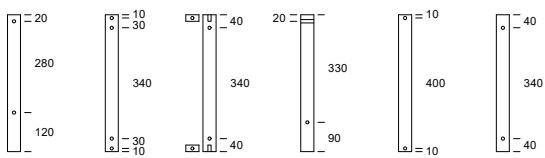

a₁ 420 8x
 a₂ 420 4x
 a₃ 420 4x
 a₄ 420 2x
 a₅ 420 9x
 a₆ 420 1x



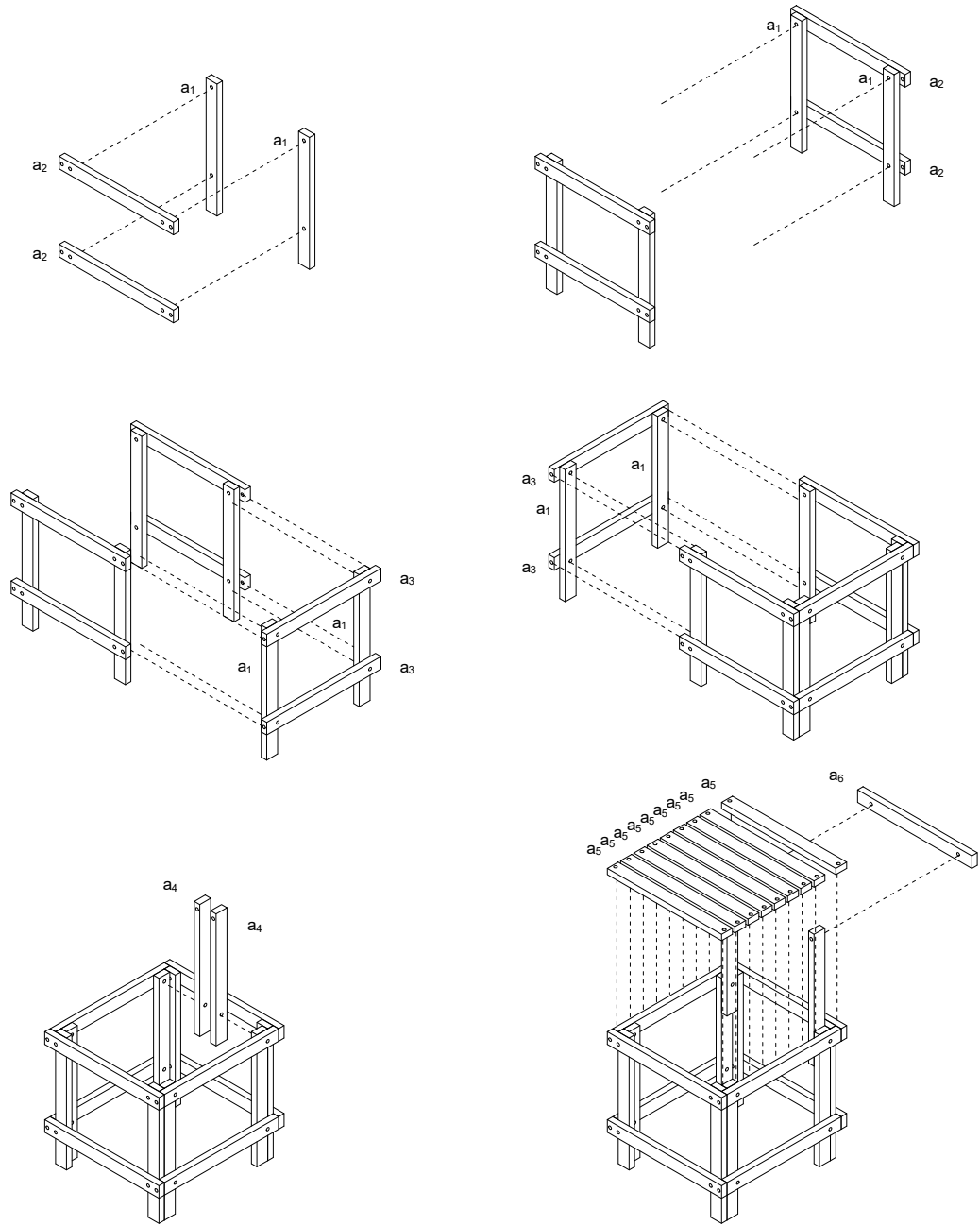

Assembly steps.

STOOL

It can also work as a table for little kids.

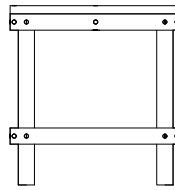
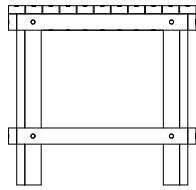
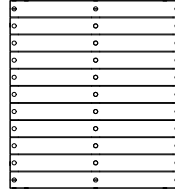
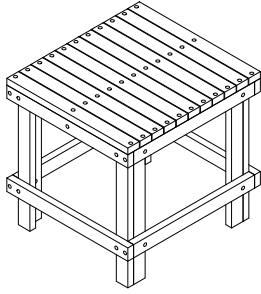

Anatomy.

material: 4 pine battens 3.000x20x40 mm
 tools: drill bit 30mm
 screws: universal screws 3,5x30mm; flathead z2

(x) = (cut width)
 -
 x = distance between predrilling centers,
 or between part end and predrilling center
 -

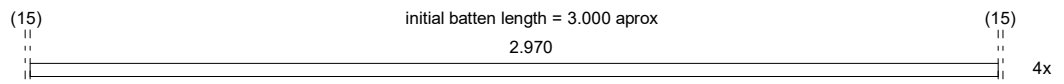

cut:

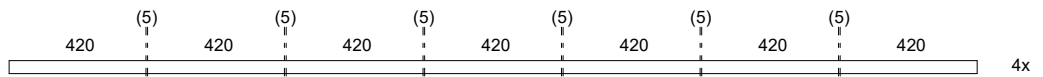

predrill:

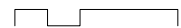
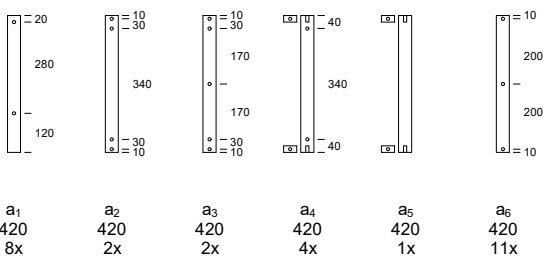

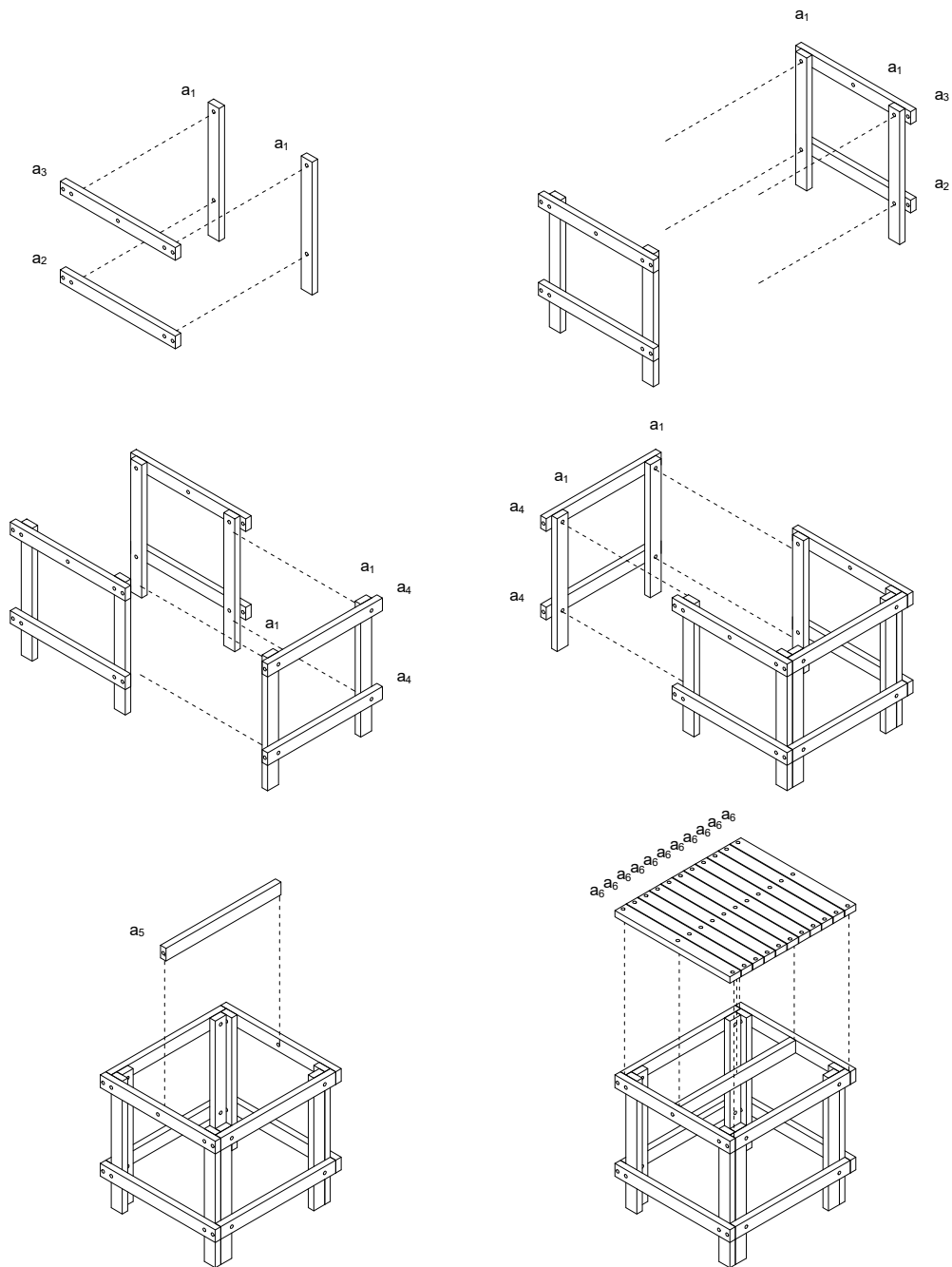

Assembly steps.

